



*01432 373350 [www.htsspares.com](http://www.htsspares.com)*

## **Waterproof Keypad Immobiliser - With RFID User Manual**



## Product Introduction

The HTS Waterproof Keypad Immobiliser - With RFID is an electronic Immobilisation device. The vehicle or machine will not be able to start until an authorized User Code or ID Card/Fob Key is introduced. Its main function is to prevent unauthorized personnel from starting or operating the machine. In addition this product is also an excellent addition for anti-theft and safety of machinery. (Compatible for other applications).

## Main specifications

- Working voltage range: 12V-60V
- Maximum Current: 15A
- Working environment: -40°C to +90°C
- Protection grade: IP65

## Operation Summary

There are two ways authorize and unlock the Immobiliser: 1. Manually inputting one of the programmed user codes. 2. Introducing a programmed ID card or Fob key. When a incorrect user code or ID card/fob is introduced, the Immobiliser will remain locked. Only when a programmed user core or ID card/fob is introduced will the Keypad Immobiliser unlock, allowing the machine to start or device unlock (Dependent on application).

## Programming Summary

The control code "0" indicates the Card/Fob adding instruction, and the control code "1" indicates the manual input user code instruction. Before using the above two operation command functions, you must enter the correct administrator password to perform programming, otherwise you cannot perform ID card/fob and manual user code entry operations. To delete a user code it needs to be overwritten: To overwrite an existing code including the pre-programmed factory user code "####" please refer to section 2.3.

At present, the Immobiliser supports up to 5 different ID cards/fobs and 10 different user codes. Each user code is composed of four digits, and the number range is between 0-9. ID cards/fobs can be cloned on request meaning an unlimited quantity can be used with the Immobiliser.

**\*The Programming administrator password is "####".**

**\*The User Code Overwrite administrator password "####".**

**\*The default user code as standard is "####" when it leaves the factory.**

## ID Card / Fob Key: Operation & Programming Procedure

### 1. ID card Operation

1.1 Place the ID card/fob close to the Keypad Immobiliser. If the ID card or Fob key is valid the Immobiliser will emit a short beep, the blue indicator light will turn on indicating that the Immobiliser has unlocked. (\*The red indicator light will flash when the ID Card is incorrect or not recognized\*)

### 1.2 ID Card / Fob Key Programming

1.2.1 Before using the ID card/fob adding instruction, first enter the programming administrator password, then press the "√" key. If the administrator password is entered correctly, the yellow indicator light will flash, if the entry is wrong, the red indicator light will flash and the operation is invalid.

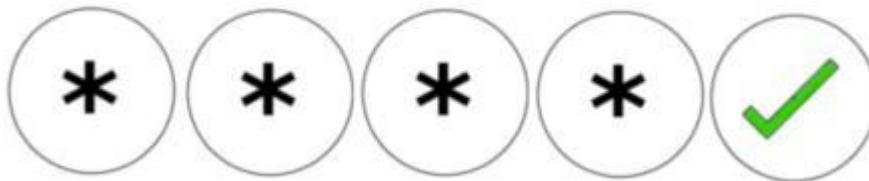

1.2.2 After the administrator password is entered correctly, enter the control code "0", then press the "√" key to enter the card adding mode, the yellow indicator light will continue to flash. Hold the ID card/fob close to the Immobiliser - The card will then program automatically, A solid blue light will follow indicating the ID card/fob has been accepted. To Note: The X2 ID cards supplied with the Immobiliser are pre-programmed at factory.

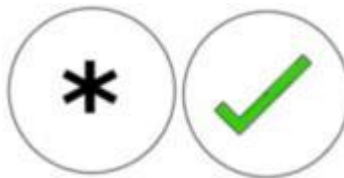

1.2.3 If you need to exit the card adding mode, press the "x" key on the panel to exit, the yellow indicator light will go out. (\*The time limit for card adding operation is 5 seconds, if you exceed 5 seconds the buzzer will beep once, and the card adding mode will end. You will need to start programming procedure again to continue adding cards.

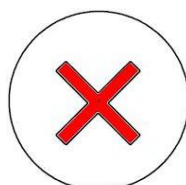

## User Code/Password: Operation & Programming Procedure

### 2.1 User Code Operation

2.1.1 When operating the Immobiliser, you only need to enter the 4 digit user code and press the "√" key. If the user code is entered correctly the Immobiliser will emit a short beep a solid blue light will follow indicating the Immobiliser has unlocked. (\*The red indicator light will flash when the password is entered incorrectly\*)

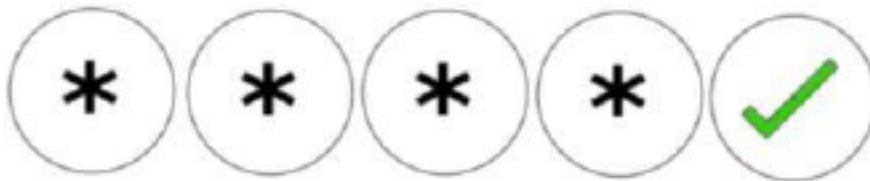

### 2.2 User Code adding procedure

2.2.1 Before using the user code adding instruction, first enter the programming administrator password, then press the "√" key. If the administrator password is entered correctly, the yellow indicator light will flash. If the entry is wrong, The red indicator light will flash and the operation is invalid.

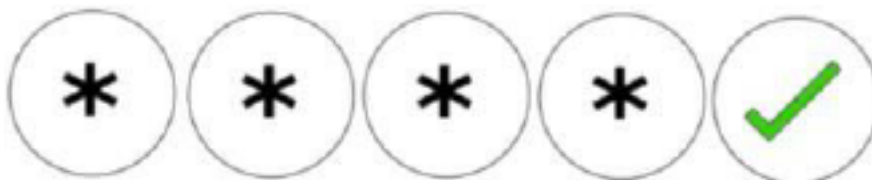

2.2.2 After the programming administrator password is entered correctly, enter the control code "1" to enter the manual user code mode, then the yellow indicator light will flash, waiting for the chosen manual entry user code.

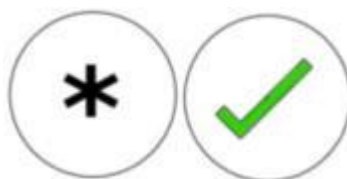

2.2.3 Enter the chosen 4 digit user code and press the "√" key. A solid blue light will follow indicating the user code has been accepted. If a user code is entered incorrectly, the red indicator light will flash. Each set of user codes must be entered separately, ending with the "√" key.

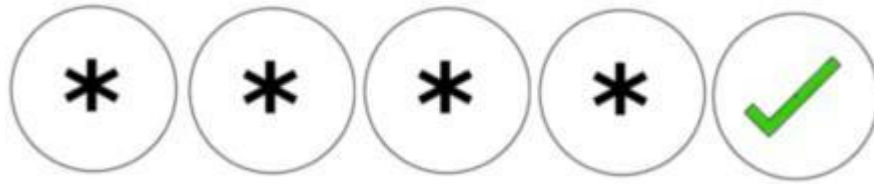

2.2.4 If you need to exit the manual password/user code entry mode, press the "x" key on the panel to exit the manual entry user code/password mode.



**\*To Note:**

\*Manually enter the 4 digit chosen user codes (up to 10 different codes), We recommend you make a record of all chosen user codes.

\*If there are already 10 codes programmed in the Immobiliser, when you enter a 11th user code, the Immobiliser will automatically overwrite the first programmed code. Please operate with caution!

\*To delete a user code it needs to be overwritten: To overwrite an existing code, including the pre-programmed factory code "####" please refer to section 2.3.

\*When the Immobiliser is in normal use, there is no need to enter the administrator password. Only when adding a new ID Card/Fob, Adding a new user code or overwriting a user code do you need to enter an administrator password for authorization. In order to prevent others from modifying the password lock data we recommend the administrator codes are not shared beyond the installer.

## User Code: Overwrite/Delete User Code Procedure

2.3.1 Before using the overwrite/delete user code instruction, first enter the overwrite administrator password, then press the "√" key. If the Overwrite administrator password is entered correctly, the yellow indicator light will flash. If the entry is wrong, The red indicator light will flash and the operation is invalid.

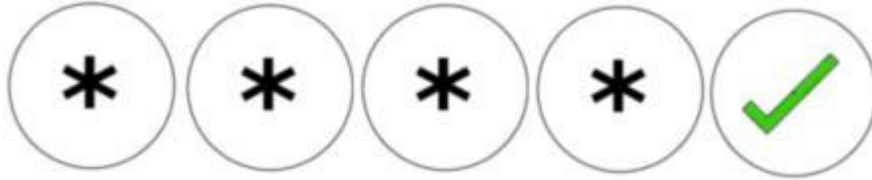

2.3.2 After the overwrite administrator password is entered correctly, enter the chosen 4 digit stored user code that will be overwritten/deleted, then press the "√" key, If the user code is entered correctly, the yellow light will flash. If the entry is wrong, The red indicator light will flash and the operation is invalid.

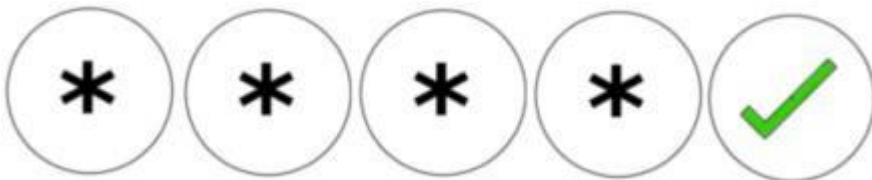

2.3.3 After the stored user code is entered correctly, enter the new chosen 4 digit user code. If the format of the new password is correct, the buzzer will sound once, the user code has been accepted and changed and the system will return to the standby state. If the entry is wrong, The red indicator light will flash and the operation is invalid.

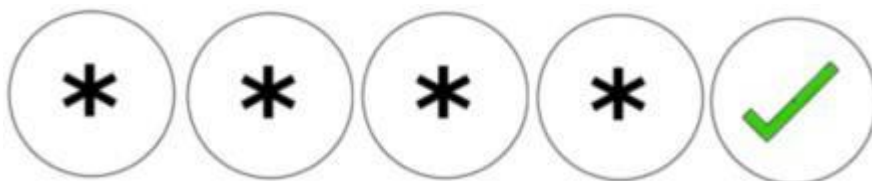

2.3.4 If you need to exit the Overwrite/Delete user code procedure, press the "x" key on the panel to exit the manual entry user code/password mode.



## Installation Instructions:

### Indicator Lights

Red light = Error indication

Yellow light = Waiting indication

Blue light = Status indication

Green light = Power indication

### Immobiliser Wire Description

<u>Wire color</u>	<u>Function</u>
Red wire	Battery/Ignition positive
Black wire	Earth
Brown wire	Switch input
Blue wire	Switch output

### **Electric vehicle connection method (Ignition Switch)**

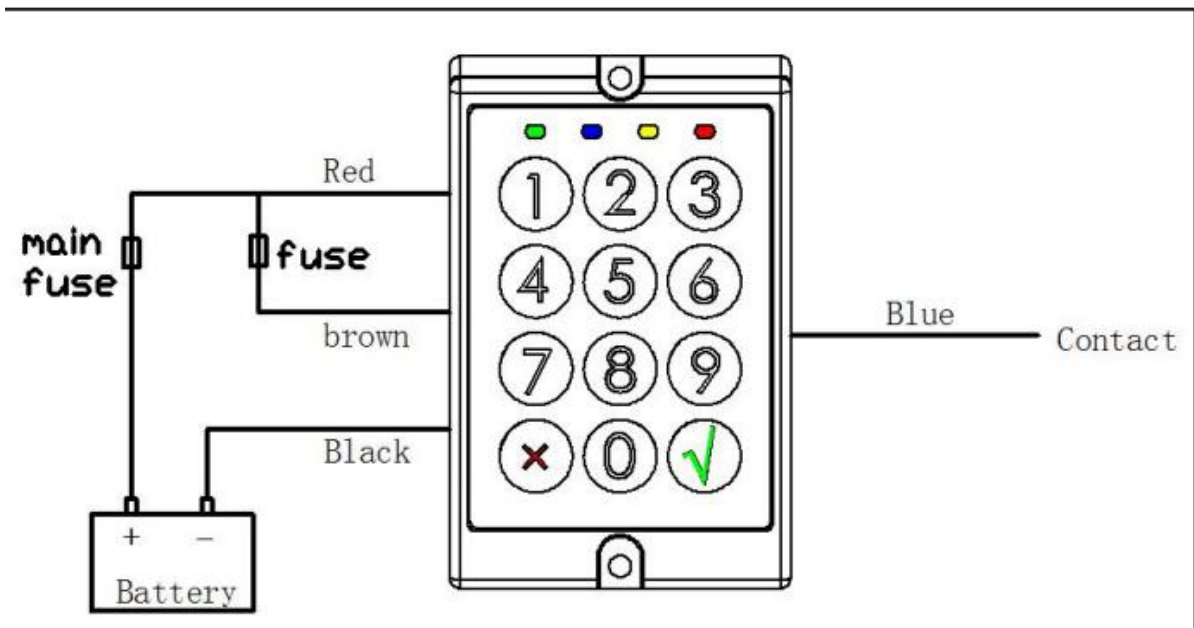

### **Installation Summary:**

There are many options for installation of the Immobilisation device depending on the machine and circuit of choice to be immobilised by the installer. We recommend the RED wire to be connected via an ignition live - This insures "preheat" and other machine systems can function correctly. Installation is recommended at ignition key.

### **System installation simplified:**

The brown and blue wires are open circuit until the keypad has been authorized and unlocked, once authorized they become closed. Choose a suitable "machine start" circuit to "T" into.

## Dimensions (Unit: mm)

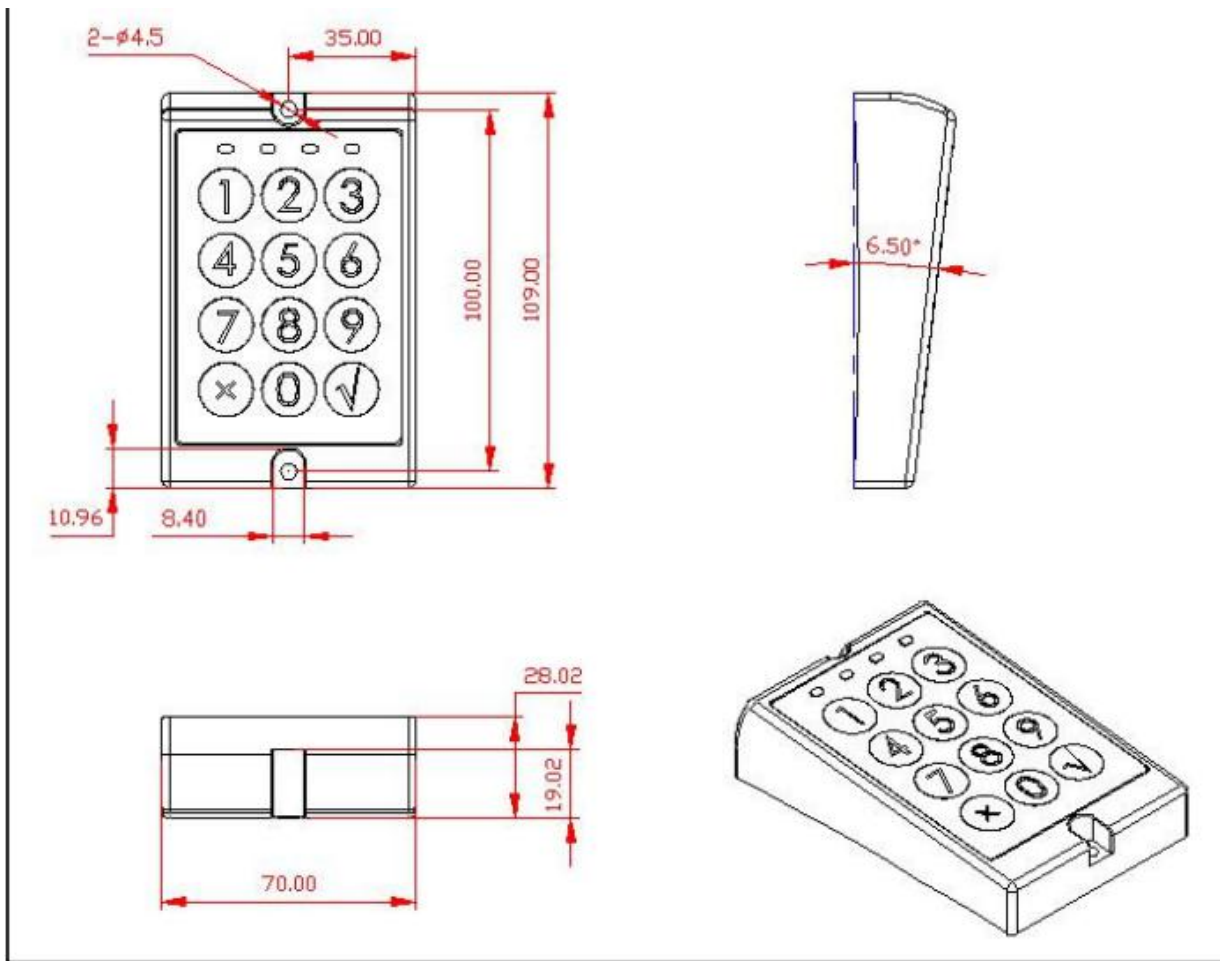

## Users Register

User Number	User Code
1	
2	
3	
4	
5	
6	
7	
8	
9	
10	